

FITTING INSTRUCTION

| Clamp mark in acc. with | | Cables joining |
|-------------------------|-----|---------------------------|
| ISO | PN | |
| 1 | L | Left directional lights |
| 2 | + | Rear fog lights |
| 3 | 31 | Ground |
| 4 | R | Right directional lights |
| 5 | 58R | Right side parking lights |
| 6 | 54 | Stoptlights |
| 7 | 58L | Left side parking lights |

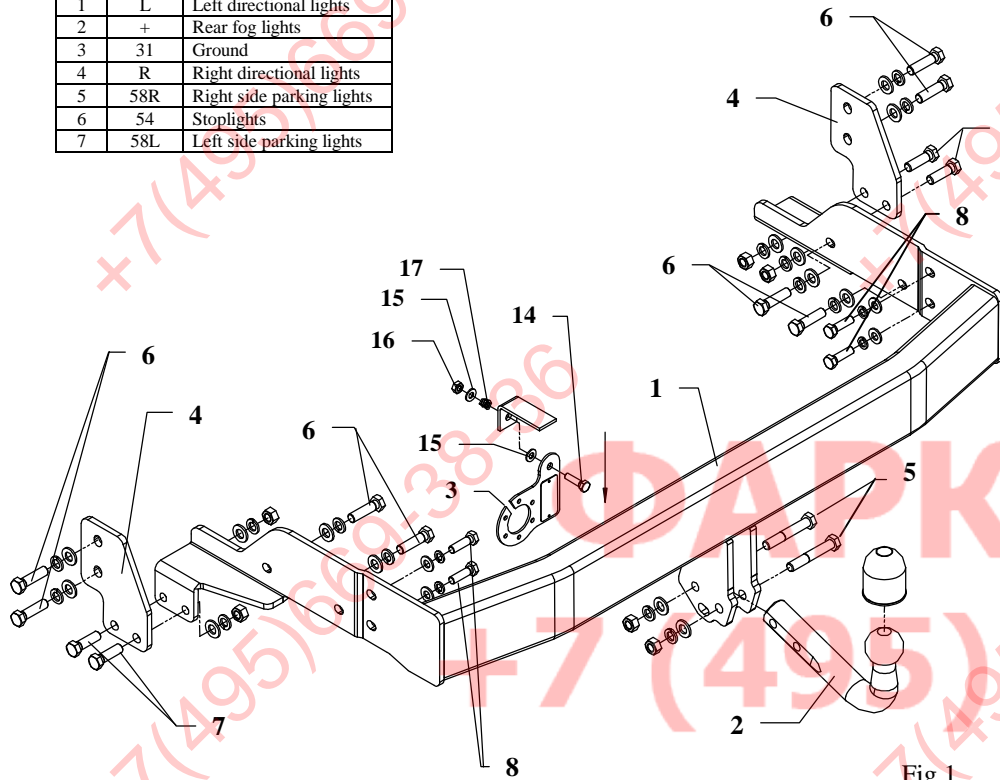

Fig.1

This towbar is designed to assembly in following cars:
KIA SORENTO (BL), 5 doors, produced since 2002 till 06.2006, catalogue no. **T41** and is prepared to tow trailers max total weight **2800 kg** and max vertical load **112 kg**.

From manufacturer

Thank you for buying our product. Their reliability has been confirmed in many tests. Reliability of towbar depends also on correct assembly and right exploit. For this reasons we kindly ask to read carefully this instruction and apply to hints.

The towbar should be install in points described by a car producer.

The instruction of the assembly

1. Take out a spare wheel.
2. Disassemble a bumper.
3. Unscrew transverse reinforcement (not used any more).
4. Put main bar (pos. 1) to frame of car in this way, so holes in towbar agree to original holes and fix all using bolts M12x45mm (pos. 6) and M10x1,25x35mm (pos. 8) – see figure 1.
5. Fish-plates pos. 4 put as shown in the figure and fix using bolts M12x45mm (pos. 6) and bolts M12x40mm (pos. 7).
6. Assemble bumper after cut out his fragment – see fig. 2.

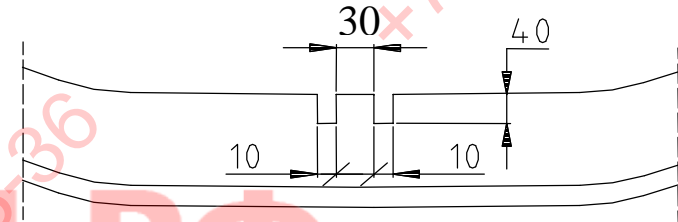

Fig. 2

7. Fix tight all bolts according to the torque shown in the table.
8. Fix tow-ball (pos. 2) using bolts M12x70mm (pos. 5) from accessories.
9. Fix the socket plate (pos. 3) as shown on the drawing.
10. Connect electric wires of 7-poles socket according to the instruction of the car. (Recommend to make at authorized service station)
11. Complete the paint coating damaged during instalment.

Torque settings for nuts and bolts (8,8):

| | | |
|--------------------|---------------------|---------------------|
| M6 - 11 Nm | M8 - 25 Nm | M10 - 50 Nm |
| M12 - 87 Nm | M14 - 138 Nm | M16 - 210 Nm |











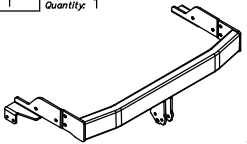
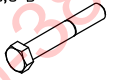

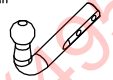



NOTE

After install the towbar you should get adequate registration in registration book (at authorised service station).The car should be equipped with:

- Indicators
- Tow mirrors

After 1000km check all bolts and nuts. The ball of towbar must be always kept clean and conserve with a grease.

Towbar accessories:

| | | | |
|--|---|--|--|
| Pos. 1 Name: Main bar Quantity: 1  | Pos. 5 Name: Bolt 8,8 B Quantity: 2 Dim.: M12x70mm  | Pos. 10 Name: Plain washer Quantity: 14 Dim.: Ø 13 mm  | Pos. 15 Name: Plain washer Quantity: 2 Dim.: Ø 8,5 mm  |
| Pos. 2 Name: Tow ball Quantity: 1  | Pos. 6 Name: Bolt 8,8 B Quantity: 8 Dim.: M12x1,5x45mm  | Pos. 11 Name: Plain washer Quantity: 4 Dim.: Ø 10,5 mm  | Pos. 16 Name: Nut 8 B Quantity: 1 Dim.: M8  |
| Pos. 3 Name: Socket plate Quantity: 1  | Pos. 7 Name: Bolt 8,8 B Quantity: 4 Dim.: M12x40mm  | Pos. 12 Name: Spring washer Quantity: 14 Dim.: Ø 12,2 mm  | Pos. 17 Name: Spring Quantity: 1  |
| Pos. 4 Name: Fish-plate Quantity: 2  | Pos. 8 Name: Bolt 8,8 B Quantity: 4 Dim.: M10x1,25x35mm  | Pos. 13 Name: Spring washer Quantity: 4 Dim.: Ø 10,2 mm  | Pos. 18 Name: Ball cover Quantity: 1  |
| | Pos. 9 Name: Nut 8 B Quantity: 6 Dim.: M12  | Pos. 14 Name: Bolt 8,8 B Quantity: 1 Dim.: M8x30mm  | |



PPUH AUTO-HAK S.J.

Produkcja Zaczepów Kulowych
Henryk & Zbigniew Nejman
76-200 SŁUPSK ul. Słoneczna 16K
tel/fax (059) 8 414-414; 8 414-413
E-mail: office@autohak.com.pl
www. autohak.com.pl

Towing hitch (without electrical set)

Class: **A50-X** Cat. no. **T41**

Designed for:

Manufacturer: **KIA**

Model: **SORENTO (BL)**

Type: **5 doors**

produced since 2002 till 06.2006

Technical data:

D-value: 13,22 kN

trailer weight: **2800 kg**

maximum vertical cup load: **112 kg**

Approval number acc. to regulations EKG/ONZ 55.01: **E20-55R-01 1462**

ФАРКОН.РФ

+7 (495) 669-38-36

Foreword

This towbar is designed according to rules of safety traffic regulations. The towing hitch is a safety component and can be install only by qualified personnel. Any alteration or conversion of the towing hitch is prohibited and would lead to cancellation of design certification. Remove insulating compound and underseal from vehicle (if present) in the area of the matting surfaces of the towing hitch. The vehicle manufacturer's specifications regarding trailer load and max. vertical cup load are decisive for driving, and values for the towing hitch cannot be exceeded.

D-value formula:

$$\frac{\text{Max trailer weight [kg]} \times \text{Max vehicle weight [kg]}}{\text{Max trailer weight [kg]} + \text{Max vehicle weight [kg]}} \times \frac{9,81}{1000} = D \text{ [kN]}$$